

CAUTION - READ MANUAL & ALL NOTES BEFORE INSTALLING OR OPERATING CONTROL. SEE NOTE 1.

WARNING: HIGH VOLTAGE

VOLTAGES PRESENT IN THIS CONTROL CAN CAUSE SEVERE OR FATAL INJURIES. NOTE: EVEN THOUGH SUPPLY POWER TO THIS UNIT HAS BEEN DISCONNECTED, THERE MAY BE VOLTAGES IN THIS CONTROL ORIGINATING FROM OTHER SOURCES.

FOR ALL VOLTAGE POTENTIAL TO BE REMOVED FROM THIS CONTROL, POWER MUST BE REMOVED FROM ALL EXTERNAL CONTROL CIRCUITS CONNECTED TO TERMINALS IN THIS CABINET.

CAUTION Control Shipped Wired for 460 VAC Unless otherwise specified - See Note 2.

CAUTION DO NOT OPERATE WITHOUT WATER ON POWER ON WITHOUT WATER FLOW MAY CAUSE DAMAGE TO CONTROL. TURN POWER OFF WHEN CONTROL IS NOT IN USE.

PARTS LIST - CONTROL SECTION 421391 B

Table with columns: QTY, DESIG, PART NO, DESCRIPTION. Lists various control components like dial plates, switches, and transformers.

PARTS LIST - CONTACTOR SECTION

Table with columns: QTY, DESIG, PART NO, DESCRIPTION. Lists contactor components like terminal strips, resistors, fuses, and solenoids.

Optional Keylock when specified by customer. See Note 8. Pack Key in Poly Bag 900148 & attach to Door w/Yellow Tape 900118. Substitution or addition of parts when 575V control is specified.

MANUFACTURING INSTRUCTIONS: See Drawing #440445 for Packing Instructions "E" Cabinet. See Drawing #440448 for Label Locations "E" Cabinet.

Revision table with columns: REV, AUTH, DESCRIPTION, DATE, CHK'D BY, DATE. Includes drawing number 421391-B.

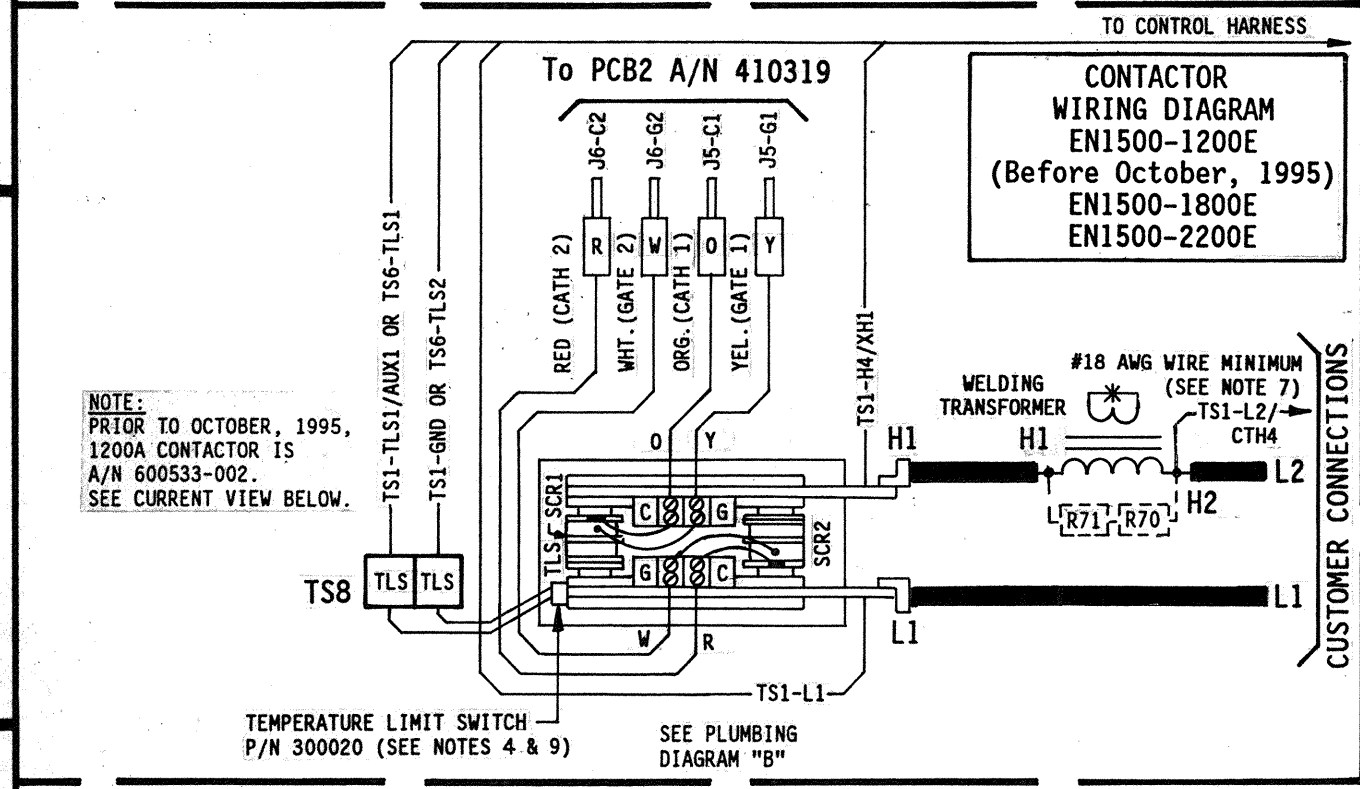
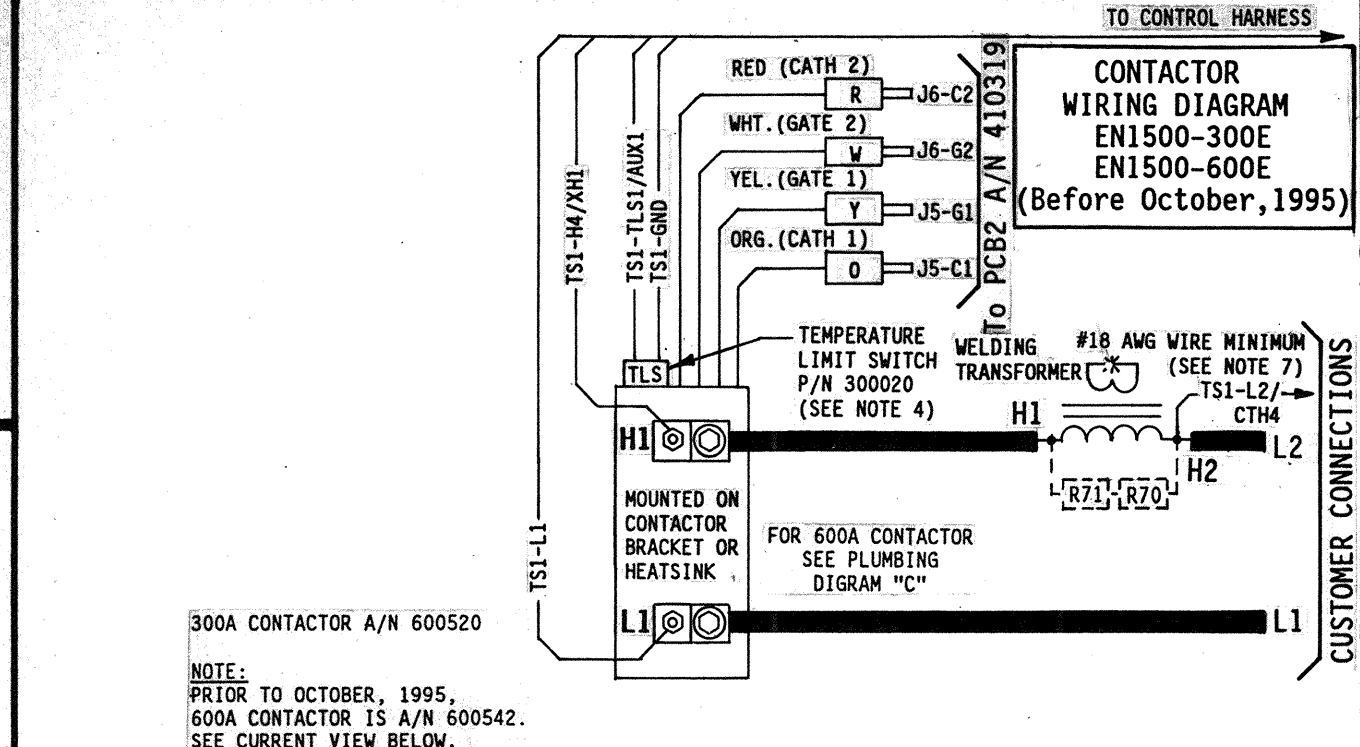

- NOTES: 1. It is recommended that control wiring (i.e., initiation, pressure switch, etc.) be physically separated from the high voltage wiring (115 volts or higher). 2. For 460 VAC Operation - Use Jumper #1 on T3 & T51. As shipped unless otherwise specified.

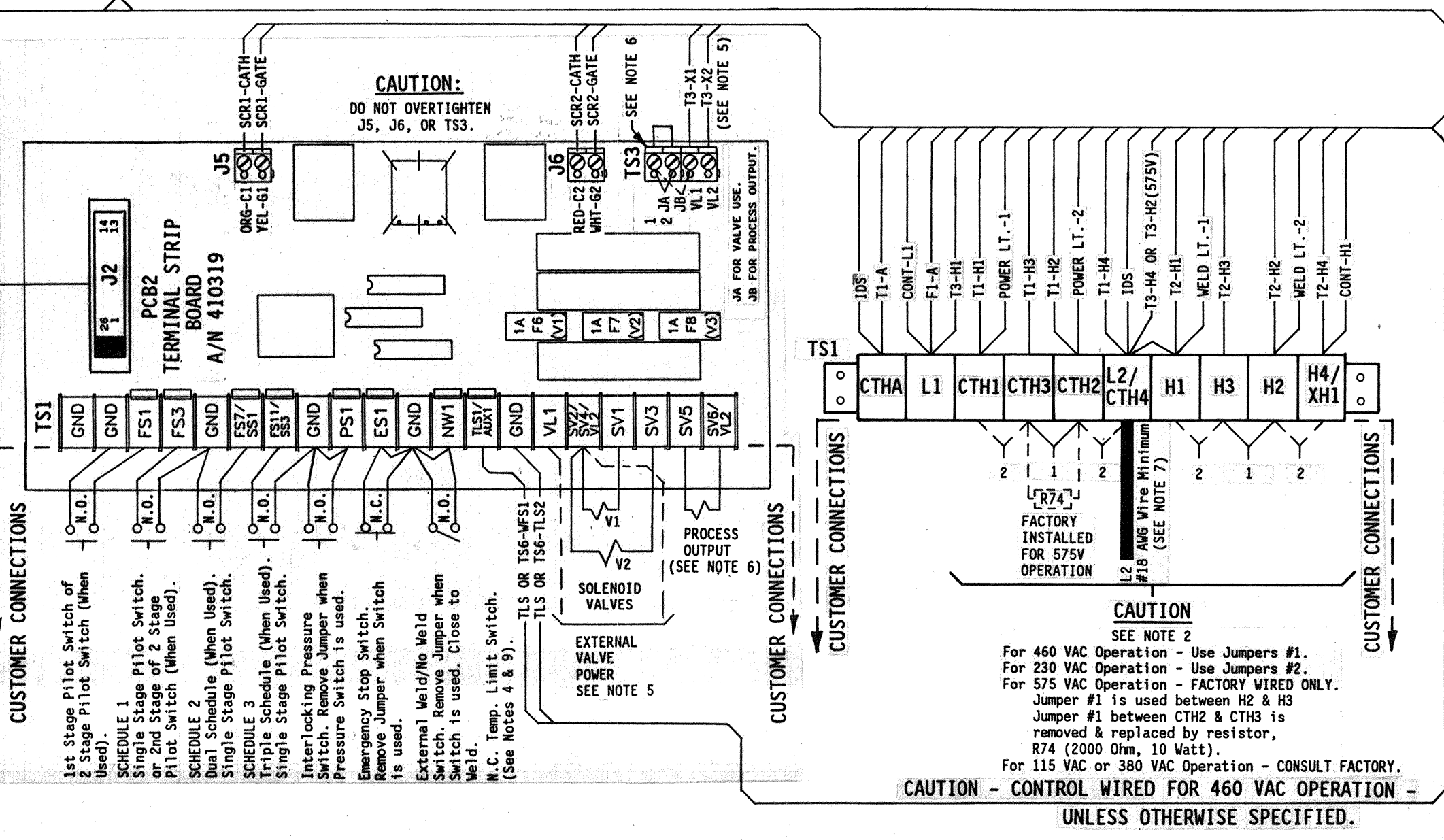
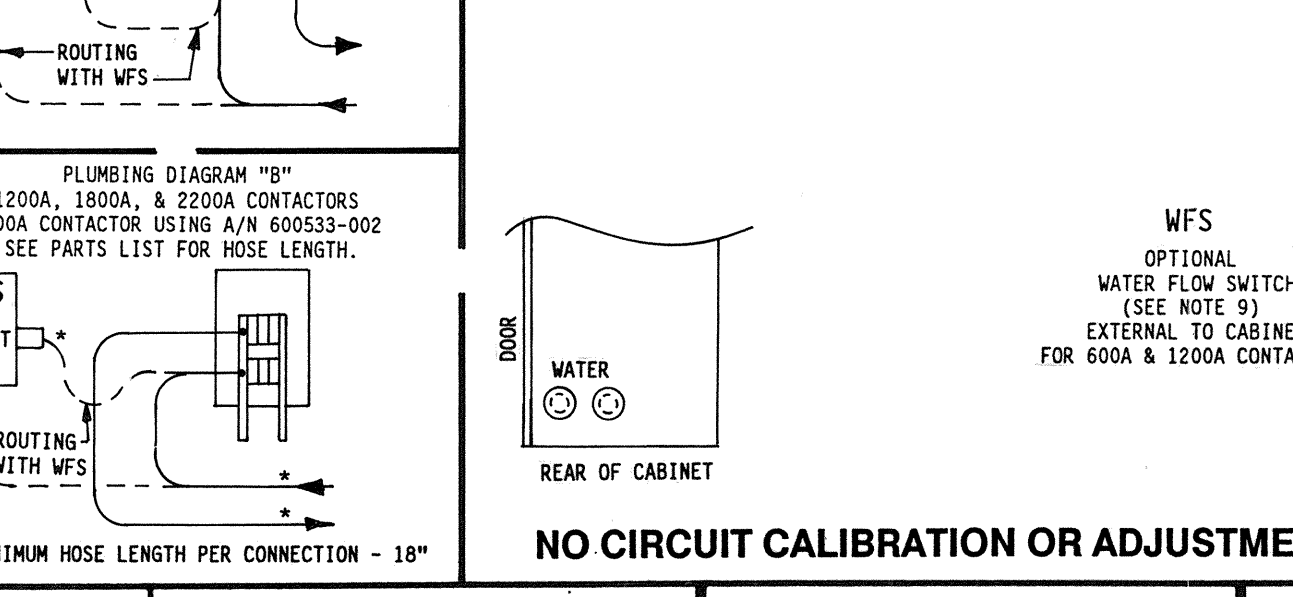
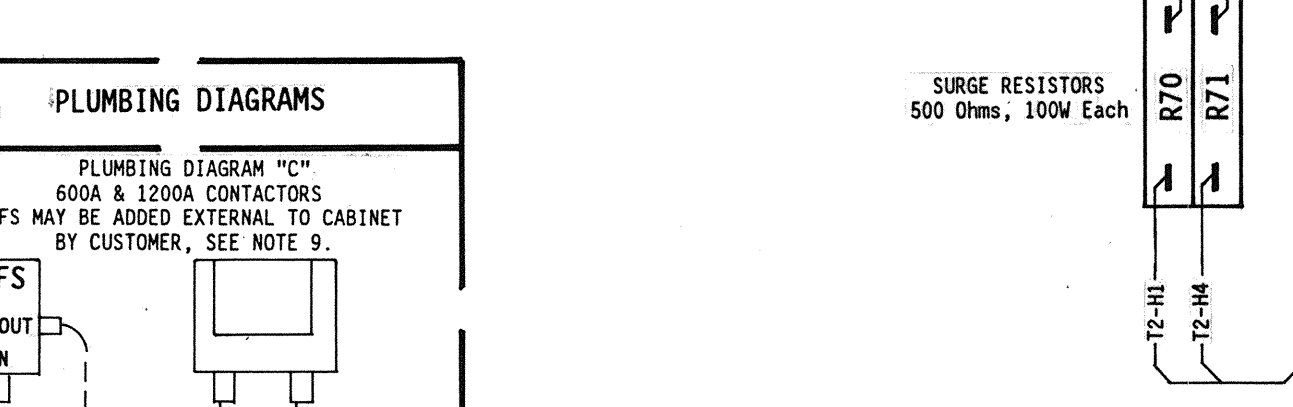
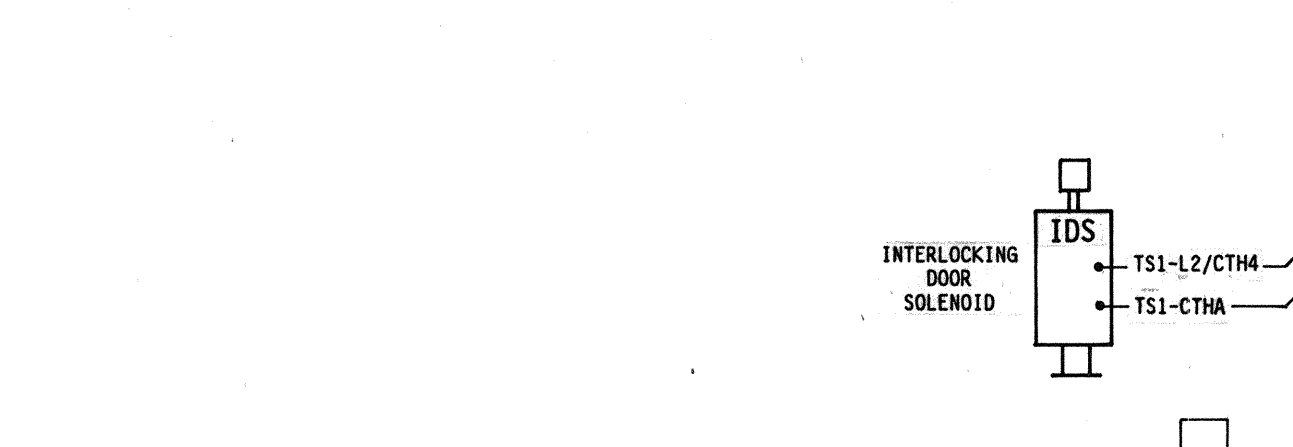
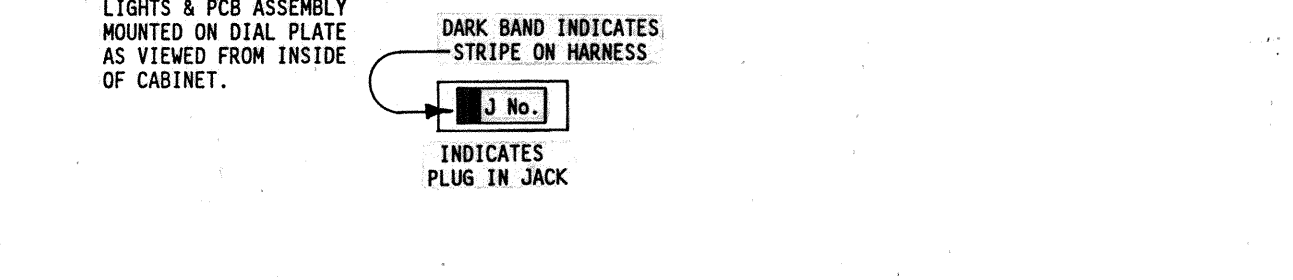
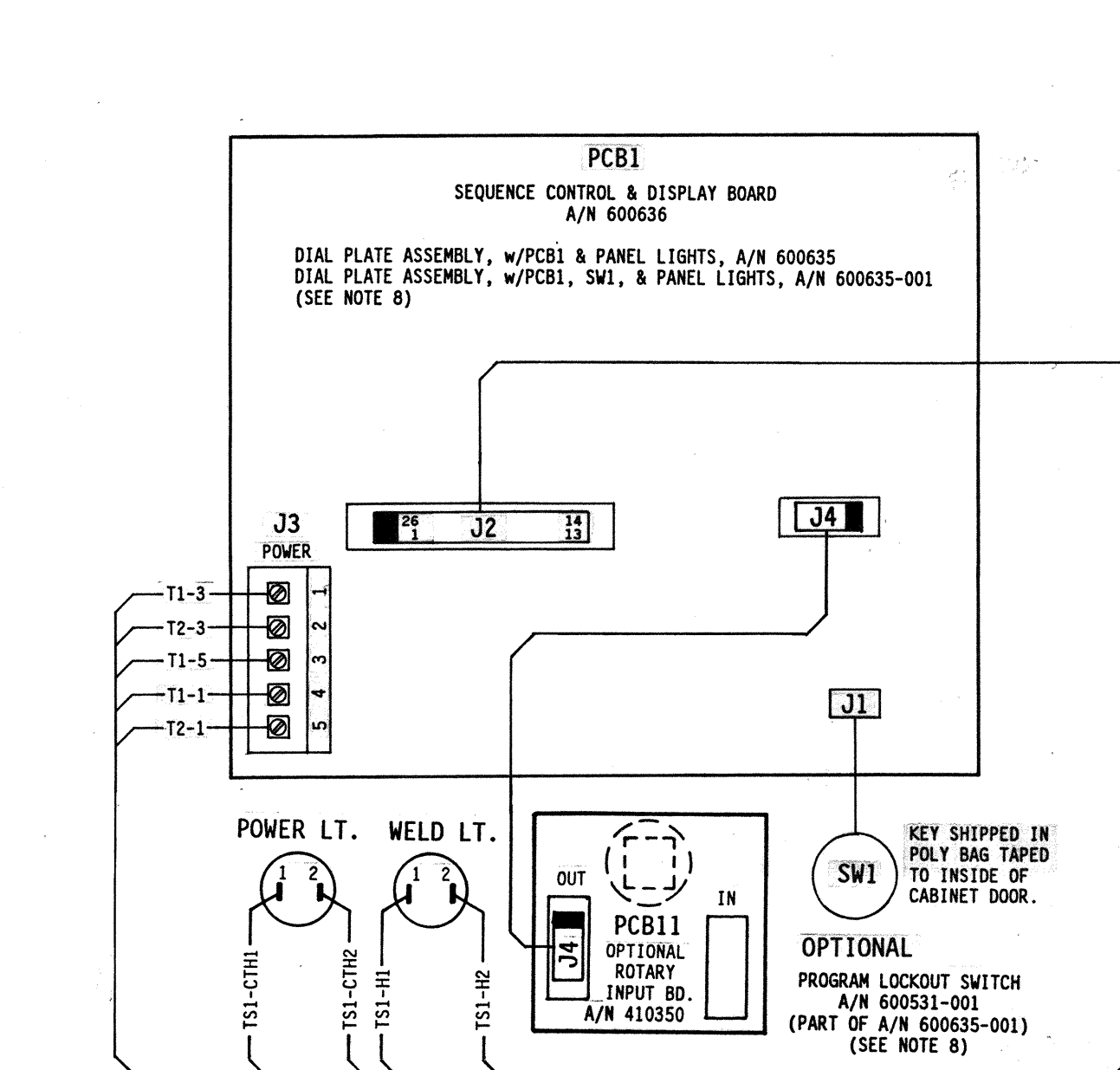
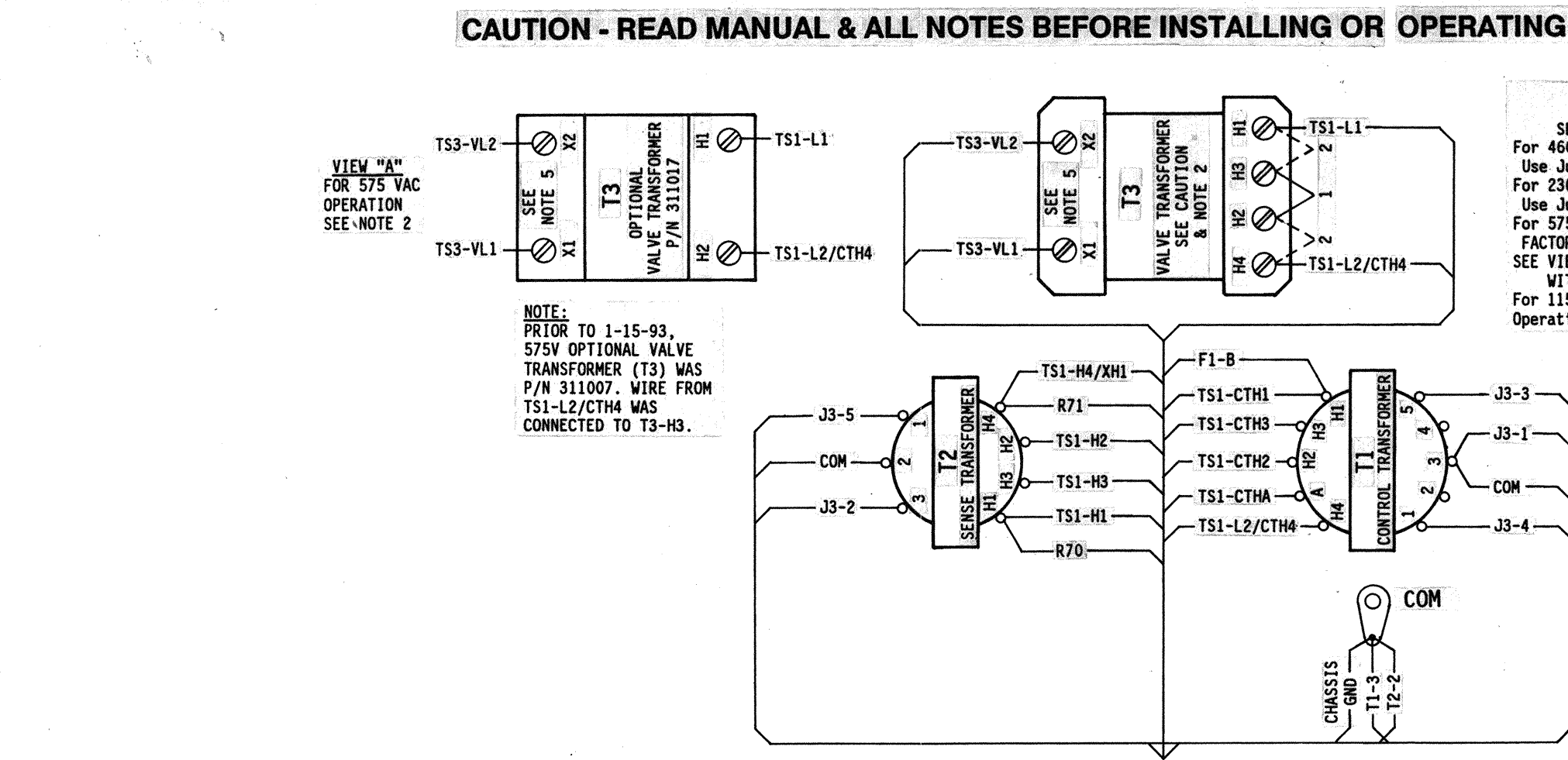
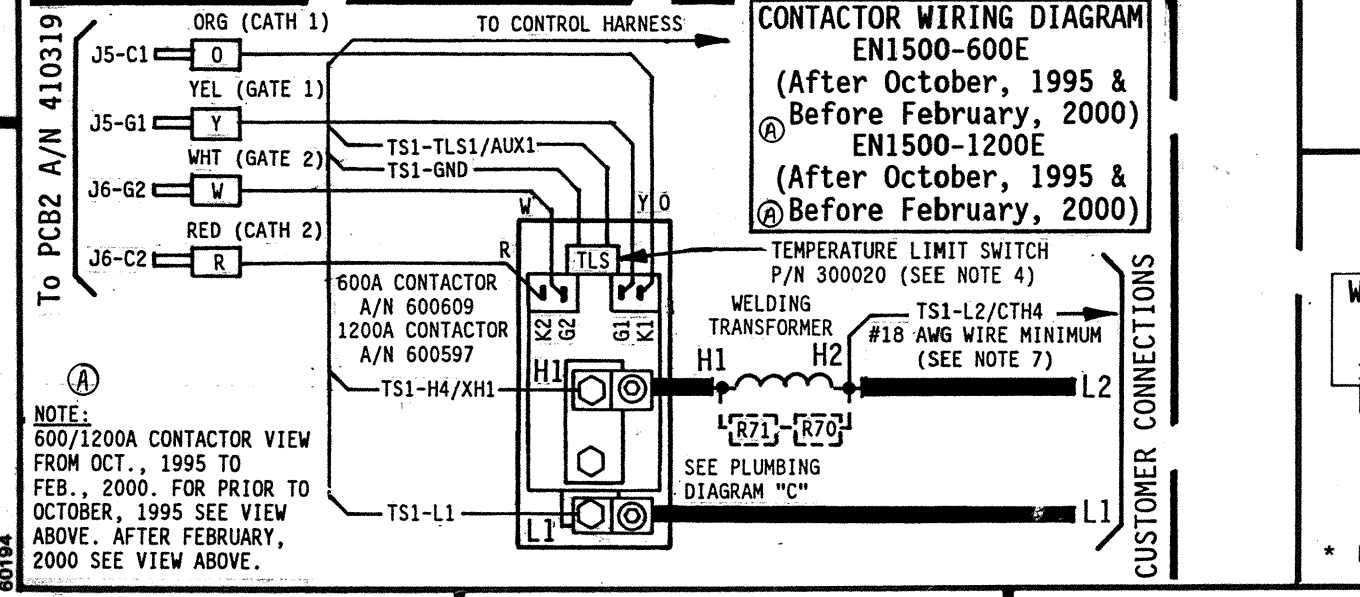
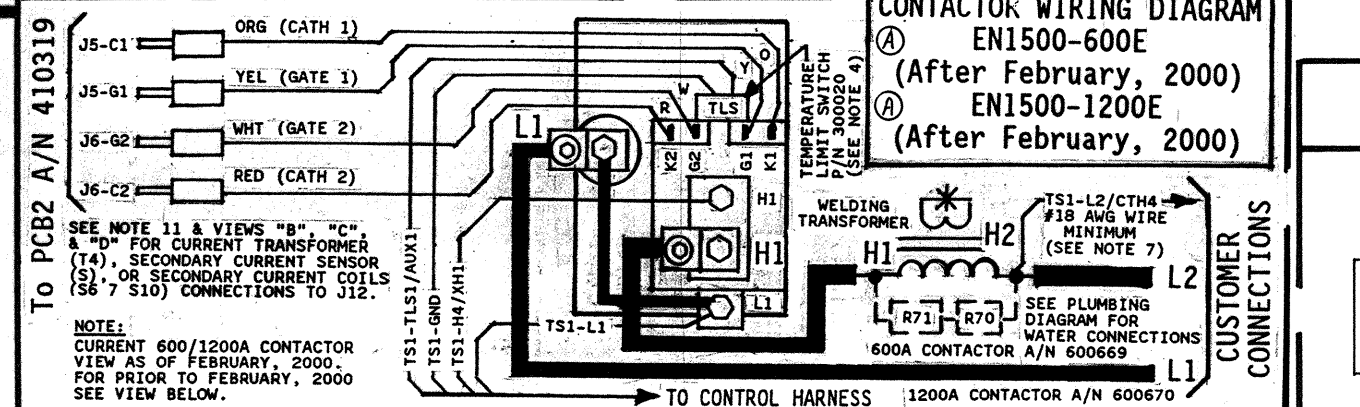
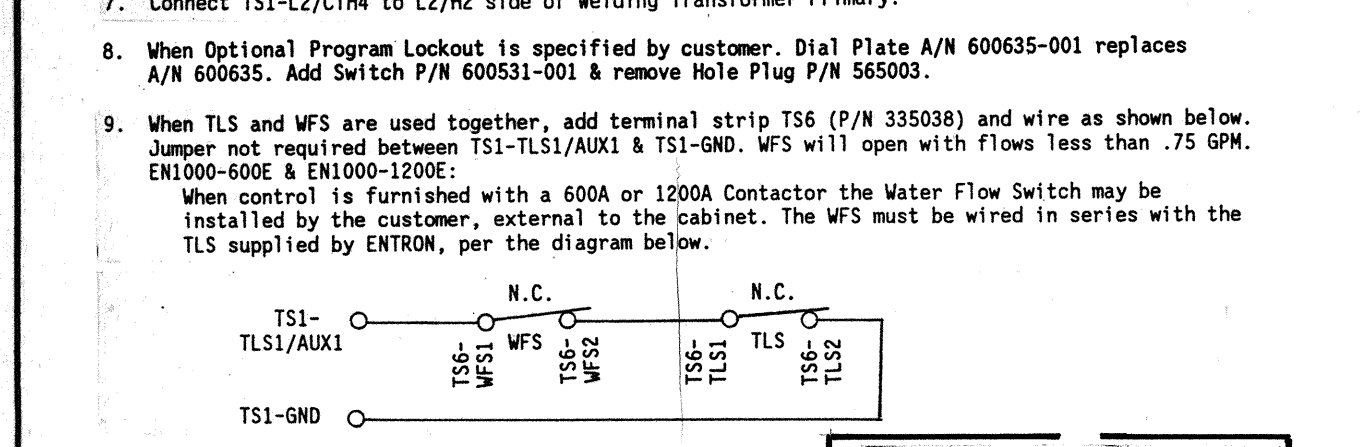

CAUTION - CONTROL WIRED FOR 460 VAC OPERATION - UNLESS OTHERWISE SPECIFIED.

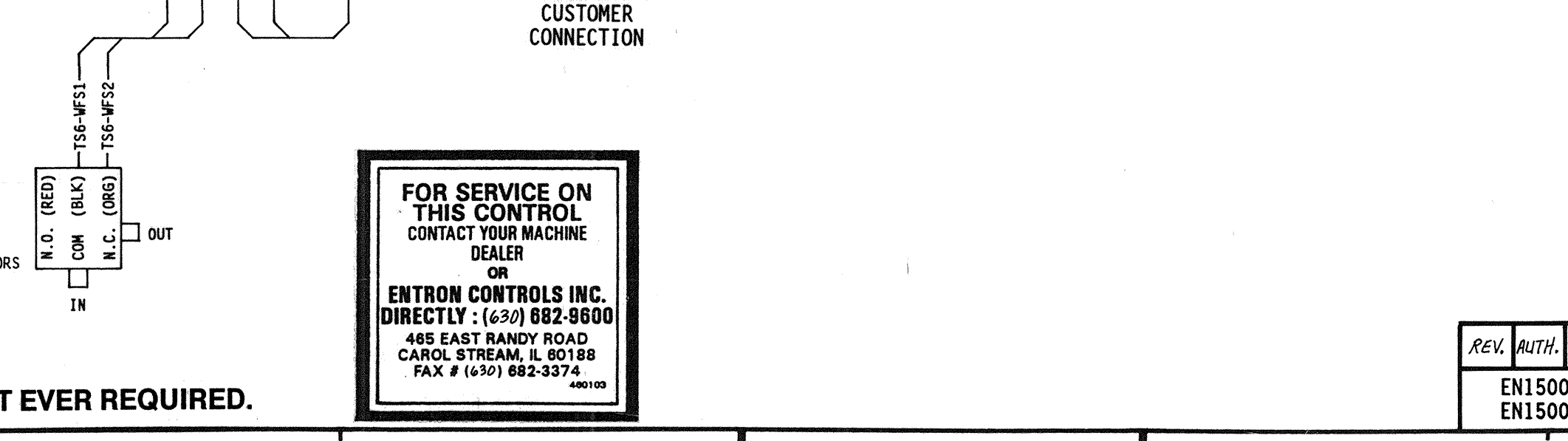
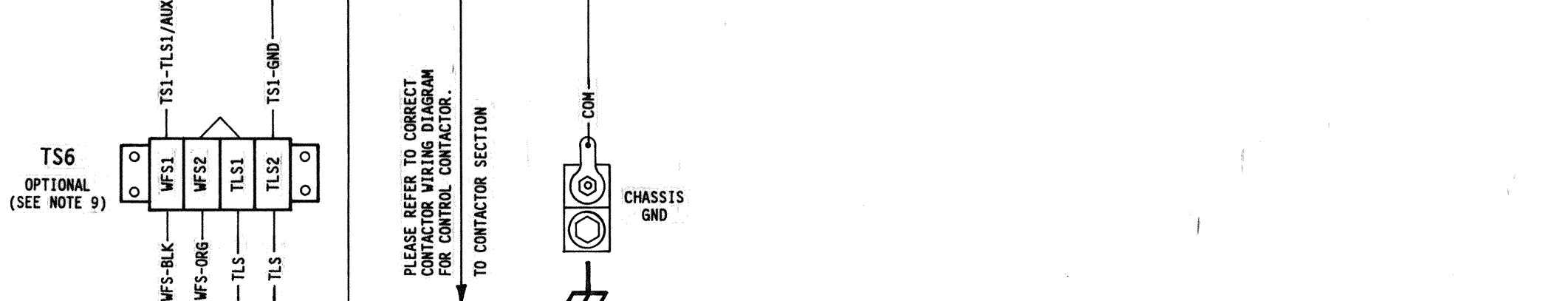

FOR SERVICE ON THIS CONTROL CONTACT YOUR MACHINE DEALER OR ENTRON CONTROLS INC. DIRECTLY: (630) 882-9600

NO CIRCUIT CALIBRATION OR ADJUSTMENT EVER REQUIRED.